

# FIBER EXPRESS ECX PATCH PANEL FRAMES PART NUMBER DESCRIPTION

PART NUMBER EXAMPLE : FC3X12LDMMAA

## BROKEN DOWN PART NUMBER

FC

3

X

12

LD

FS

## OPTIONAL NUMBER CONFIGURATIONS

A

A

**FC**

FIBER TYPE	
1	OM1
3	OM3
4	OM4
s	OS2

PRODUCT FAMILY	
X	FX ECX Cassettes

PORT COUNT (PATCH SIDE)	
00	0 PORTS
03	3 PORTS
04	4 PORTS
06	6 PORTS
08	8 PORTS
12	12 PORTS
16	16 PORTS
18	18 PORTS

CONNECTOR (PATCH SIDE)	
<b>LC TYPE</b>	
LD	LC DUPLEX
LA	LC/APC DUPLEX
<b>SC TYPE</b>	
SD	SC DUPLEX
SC	SC SIMPLEX
SA	SC/APC DUPLEX
SB	SC/APC SIMPLEX
<b>ST TYPE</b>	
ST	ST
MP	MPO Up/Down
KC	KEYCONNECT
<b>BB TYPE</b>	
BB	BLANK

CONNECTOR (TRUNK SIDE)	
FS	Fiber Splicing

POLARITY (OPTIONAL)	
A	TYPE-A
1	TYPE-A ALT

ADAPTER COLOR (OPTIONAL)	
<b>STANDARD ADAPTERS</b>	
T	BEIGE (TYP. OM1)
N	BLACK (TYP. OM2)
A	AQUA (TYP. OM3 OR OM4)
E	ERIKA VIOLET (TYP. OM4)
B	BLUE (TYP. OS2/UPC)
G	GREEN (TYP. OS2/APC)
<b>LC/KEYED ADAPTERS</b>	
B	BLUE
O	ORANGE
G	GREEN
M	BROWN (MAROON)
S	GRAY (SLATE)
W	WHITE
R	RED
N	BLACK (NOIR)
Y	YELLOW
V	VIOLET
P	ROSE (PINK)
A	AQUA

**PROPRIÉTÉ INTELLECTUELLE**  
L'information contenue dans ce document est la propriété de BELDEN Inc. Sauf si spécifié par une autorisation écrite de BELDEN Inc. la personne qui consulte ce document : (1) doit garder confidentielle toute l'information contenue dans ce document et doit protéger en tout ou en partie toute divulgation à toute tierce personne et (2) doit utiliser l'information pour la production ou la mise à jour.

**PROPRIETARY INFORMATION**  
The information contained in this document is the property of BELDEN INC. Except as specifically authorized in writing by BELDEN, INC. the holder of this document: (1) shall keep all information contained herein confidential and shall protect same in whole or in part from disclosure and dissemination to all third parties and (2) shall use same for operating and maintenance purposes only.

**DESSIN NON À L'ÉCHELLE**  
CE DESSIN REPRÉSENTE LE PRODUIT FINI ET DOIT ÊTRE CONSIDÉRÉ À TITRE DE RÉFÉRENCE SEULEMENT

**DO NOT SCALE DRAWING**  
THIS DRAWING REPRESENTS FINISH PRODUCT AND SHOULD BE CONSIDERED AS REFERENCE ONLY

DESSINÉ PAR: LE  
DRAWN BY: AB ON THE 03 Feb 2017

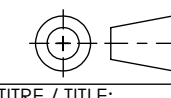
ORIENTATION: 

TITRE / TITLE:  
**FX ECX PATCH PANEL FRAMES**

DESSIN NO / DRAWING NO. REV  
**BELDEN-535 A**

FORMAT POIDS / WEIGHT FEUILLE DE  
SIZE lbs (Ref) SHEET 1 OF 4  
C

1.48in  
[37.5mm]

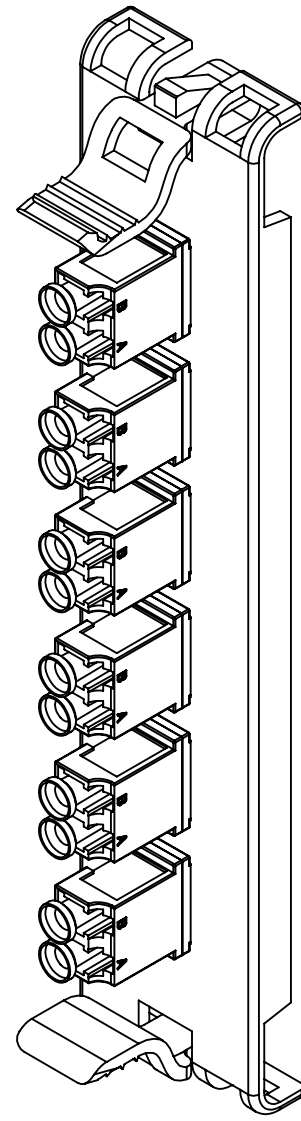
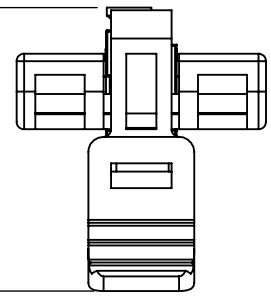

1.30in  
[33mm]

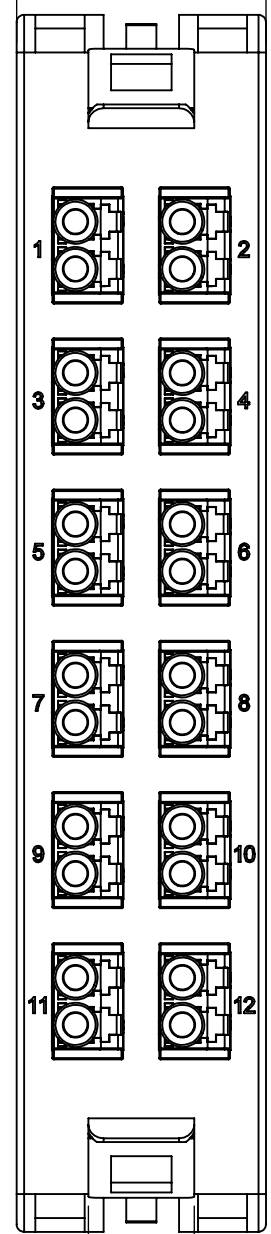

.55in  
[14mm]

6.34in  
[161mm]

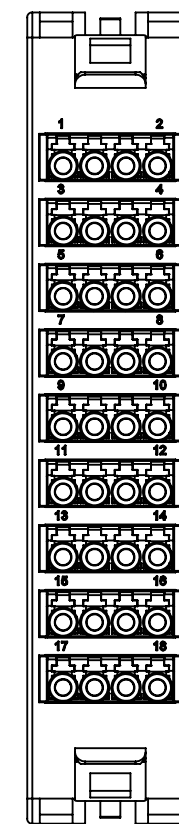
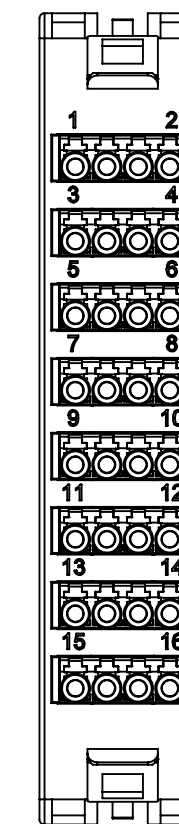
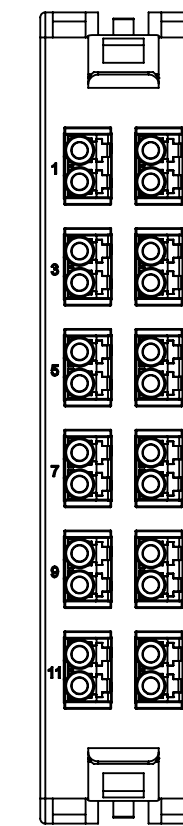
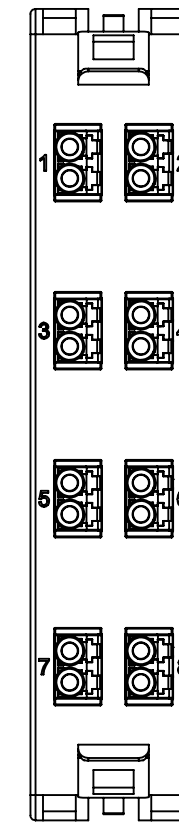
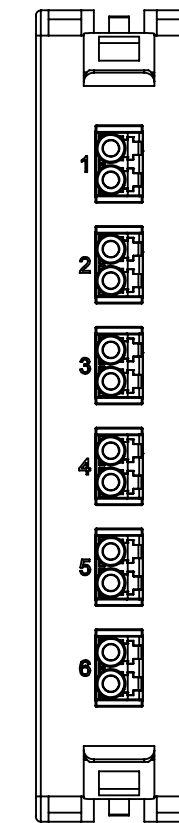
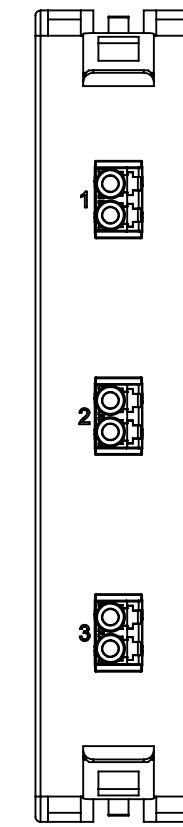
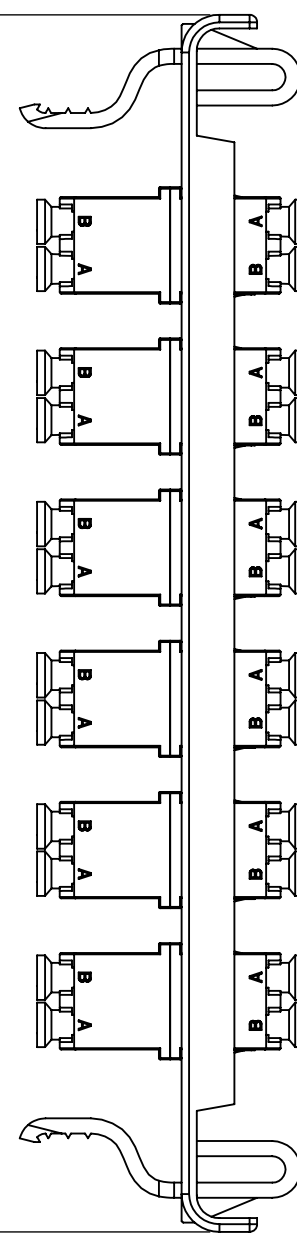

PRODUCT FAMILY : FX ECX Frame (X) LC Duplex  
FC\_X\_LD\_

**PROPRIÉTÉ INTELLECTUELLE**

L'information contenue dans ce document est la propriété de BELDEN Inc. Sauf si spécifié par une autorisation écrite de BELDEN Inc. la personne qui consulte ce document : (1) doit garder confidentielle toute l'information contenue dans ce document et doit protéger en tout ou en partie toute divulgation à toute tierce personne et (2) doit utiliser l'information pour la production ou la mise à jour.

**PROPRIETARY INFORMATION**

The information contained in this document is the property of BELDEN INC. Except as specifically authorized in writing by BELDEN, INC. the holder of this document: (1) shall keep all information contained herein confidential and shall protect same in whole or in part from disclosure and dissemination to all third parties and (2) shall use same for operating and maintenance purposes only.

**DESSIN NON À L'ÉCHELLE**

CE DESSIN REPRÉSENTE LE PRODUIT FINI, ET DOIT ÊTRE CONSIDÉRÉ À TITRE DE RÉFÉRENCE SEULEMENT

**DO NOT SCALE DRAWING**

THIS DRAWING REPRESENTS FINISH PRODUCT AND SHOULD BE CONSIDERED AS REFERENCE ONLY

DESSINÉ PAR: LE  
DRAWN BY: AB ON THE 03 Feb 2017

ORIENTATION:



TITRE / TITLE:

**FX ECX PATCH PANEL FRAMES**

DESSIN NO / DRAWING NO.

**BELDEN-535**

REV

**A**

FORMAT SIZE

**C**

POIDS / WEIGHT lbs (Ref)

FEUILLE DE SHEET 2 OF 4

CAO / CAD



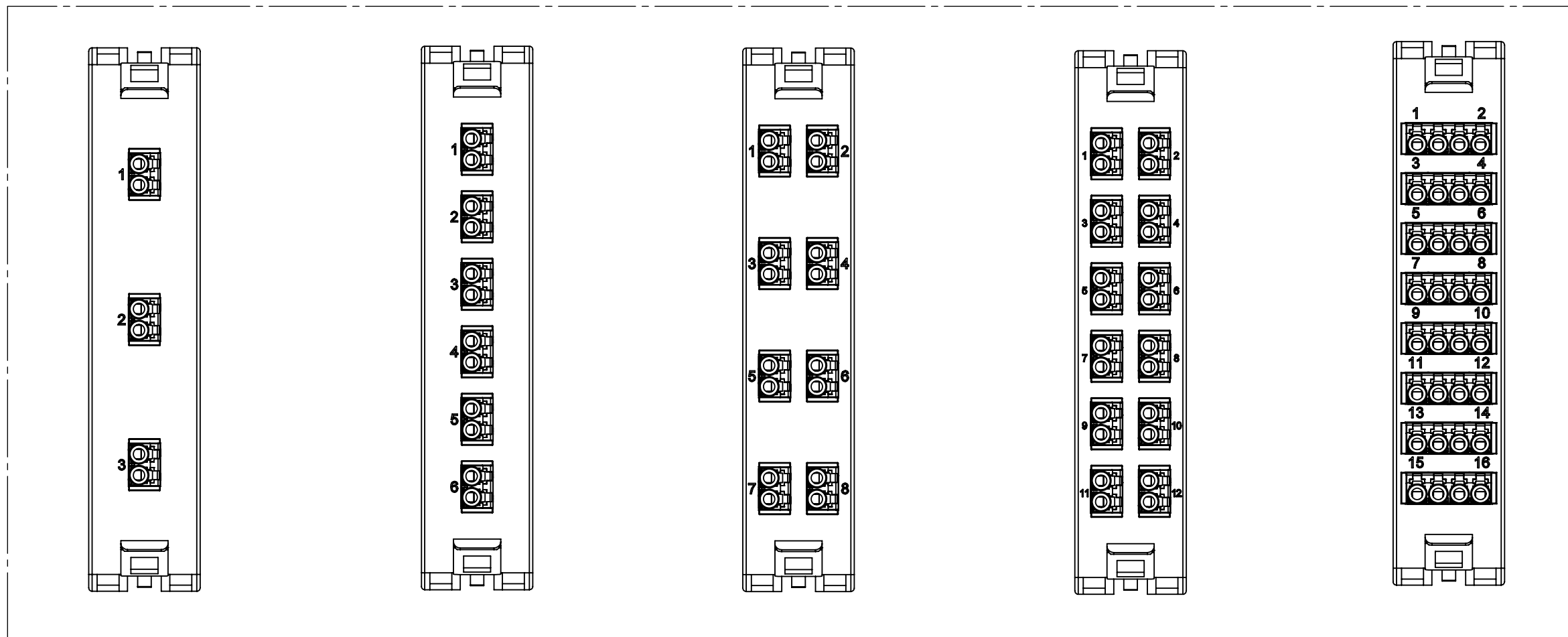

PRODUCT FAMILY : FX ECX Frame (X) LC/APC Duplex  
FC\_X\_LA\_\_\_\_\_

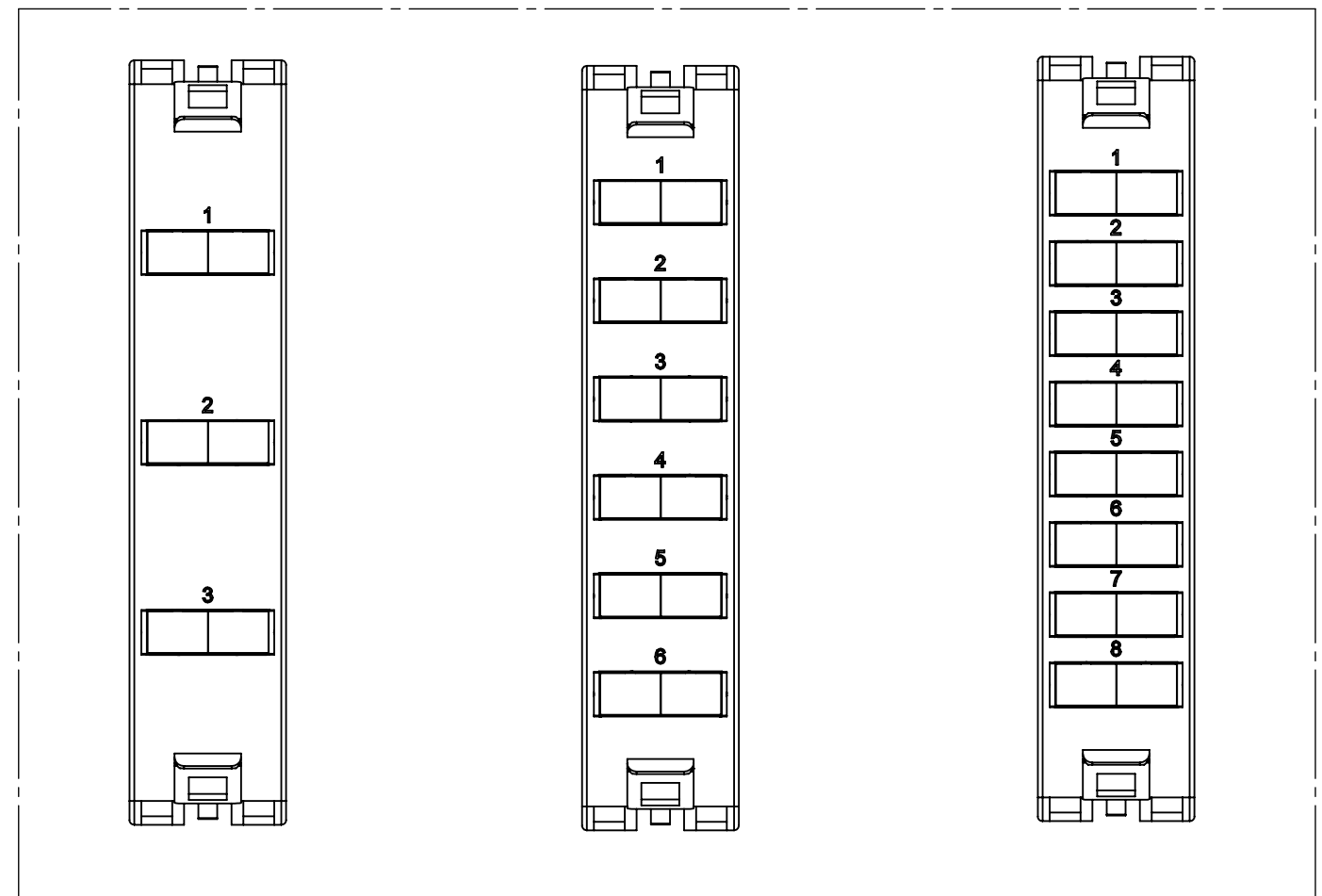

PRODUCT FAMILY : FX ECX Frame (X) SC Duplex  
FC\_X\_SD\_\_\_\_\_

PRODUCT FAMILY : FX ECX Frame (X) SC/APC Duplex  
FC\_X\_SA\_\_\_\_\_

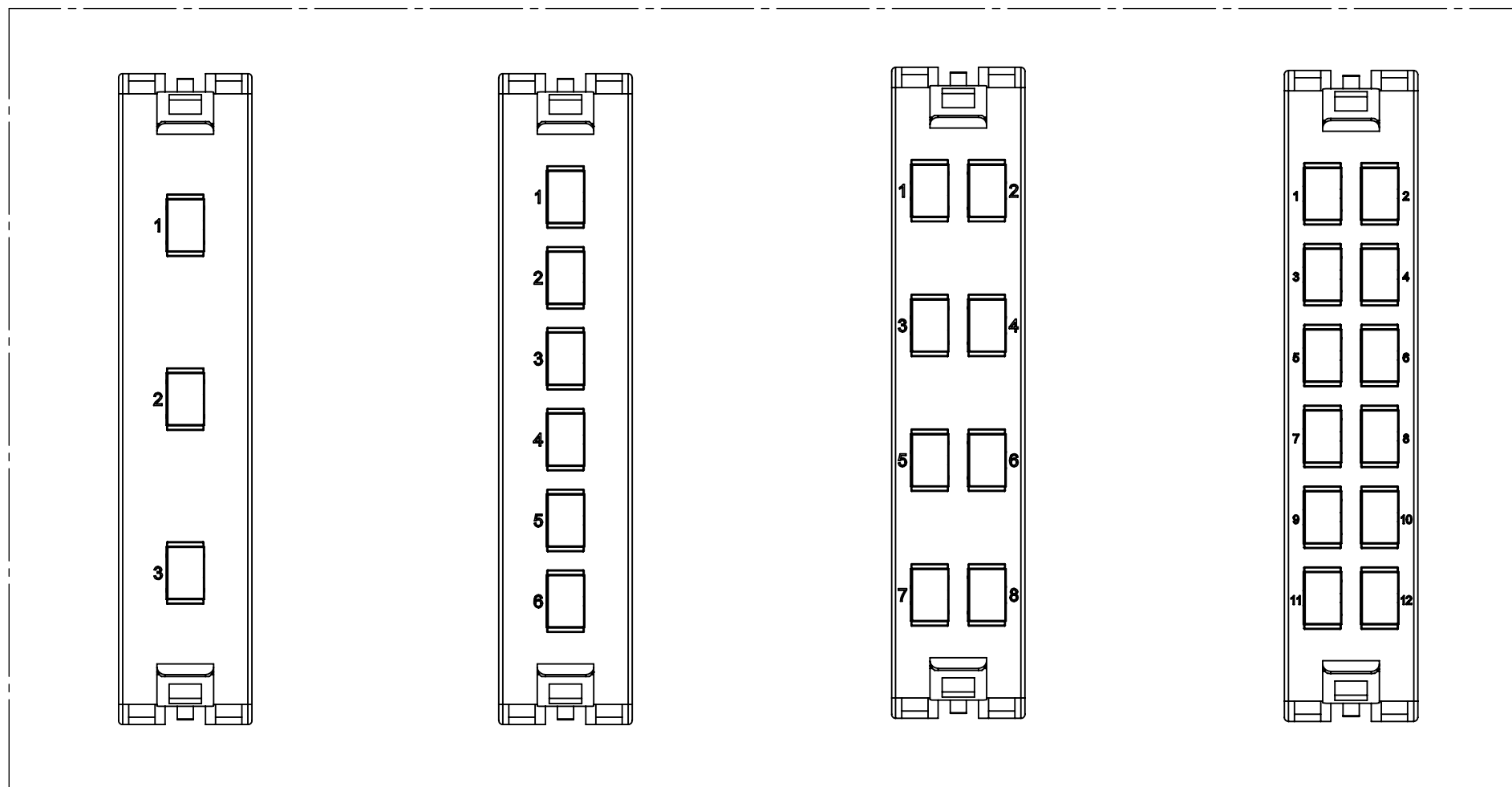

PRODUCT FAMILY : FX ECX Frame (X) SC/APC Simplex  
FC\_X\_SB\_\_\_\_\_

PRODUCT FAMILY : FX ECX Frame (X) SC Simplex  
FC\_X\_SC\_\_\_\_\_

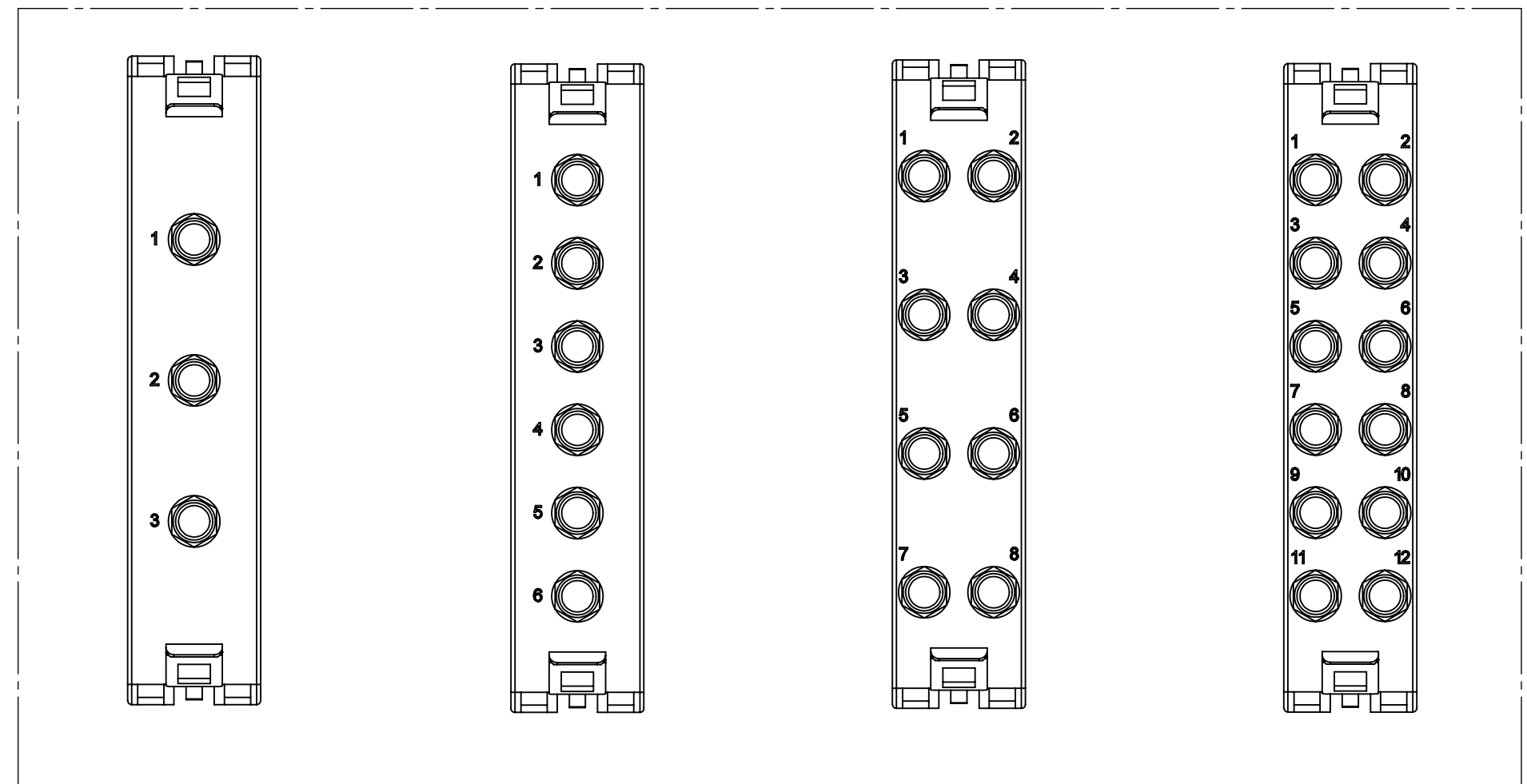

PRODUCT FAMILY : FX ECX Frame (X) ST  
FC\_X\_ST\_\_\_\_\_

**PROPRIÉTÉ INTELLECTUELLE (X)**  
L'information contenue dans ce document est la propriété de BELDEN INC. Sa diffusion est autorisée par une autorisation écrite de BELDEN INC. la personne qui consulte ce document : (1) doit garder confidentielle toute l'information contenue dans ce document et doit protéger en tout ou en partie toute divulgation à toute tierce personne et (2) doit utiliser l'information pour la production ou la mise à jour.

**PROPRIETARY INFORMATION**  
The information contained in this document is the property of BELDEN INC. Except as specifically authorized in writing by BELDEN, INC. the holder of this document: (1) shall keep all information contained herein confidential and shall protect same in whole or in part from disclosure and dissemination to all third parties and (2) shall use same for operating and maintenance purposes only.

**DESSIN NON À L'ÉCHELLE**

CE DESSIN REPRÉSENTE LE PRODUIT FINI ET DOIT ÊTRE CONSIDÉRÉ À TITRE DE RÉFÉRENCE SEULEMENT

**DO NOT SCALE DRAWING**

THIS DRAWING REPRESENTS FINISH PRODUCT AND SHOULD BE CONSIDERED AS REFERENCE ONLY

DESSINÉ PAR: LE  
DRAWN BY: AB ON THE 03 Feb 2017

ORIENTATION:



TITRE / TITLE:  
**FX ECX PATCH PANEL FRAMES**

DESSIN NO / DRAWING NO. REV  
**BELDEN-535 A**

FORMAT POIDS / WEIGHT  
SIZE lbs (Ref) FEUILLE DE SHEET 3 OF 4



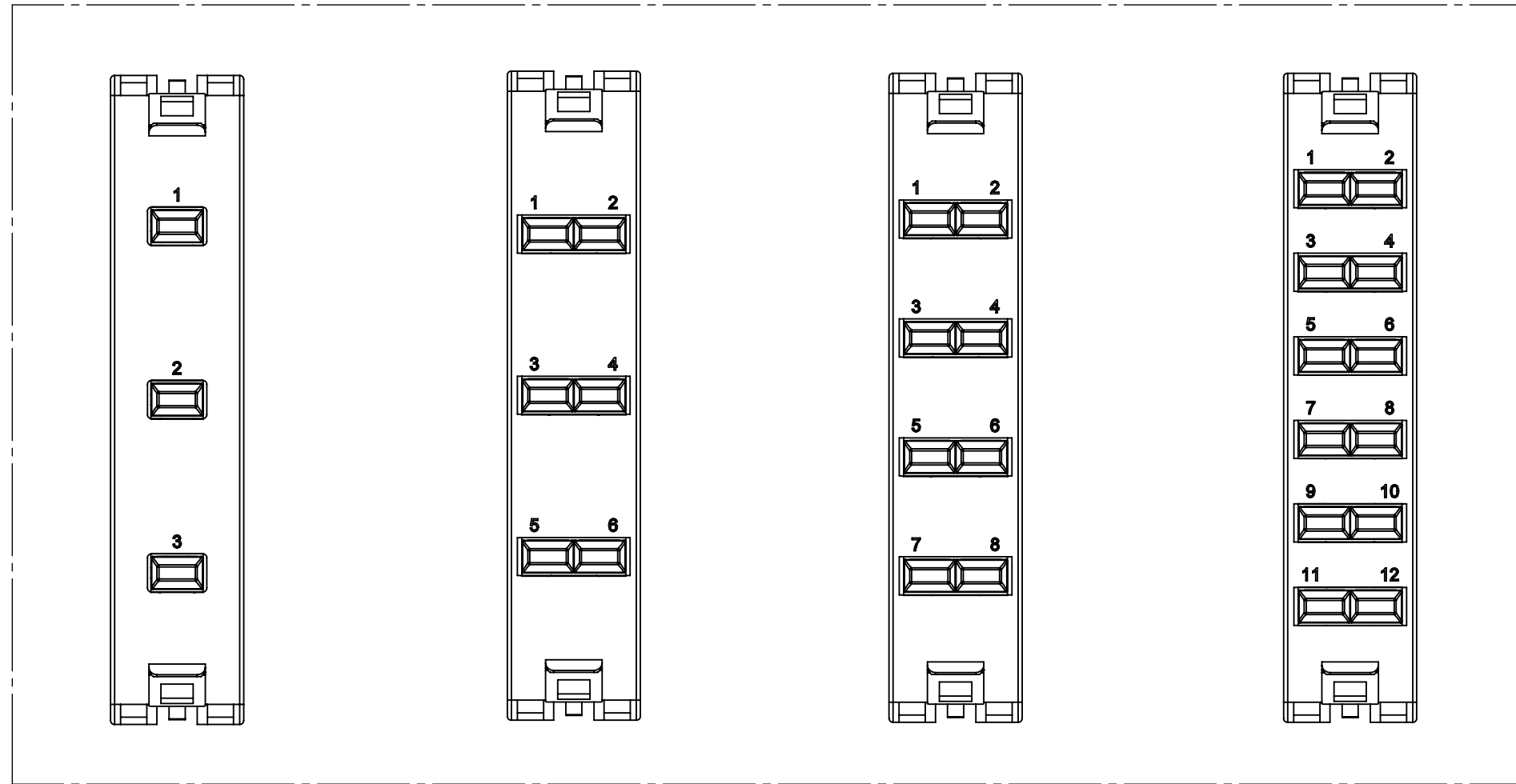

PRODUCT FAMILY : FX ECX Frame (X) MPO Up/Down  
FC\_X\_MP

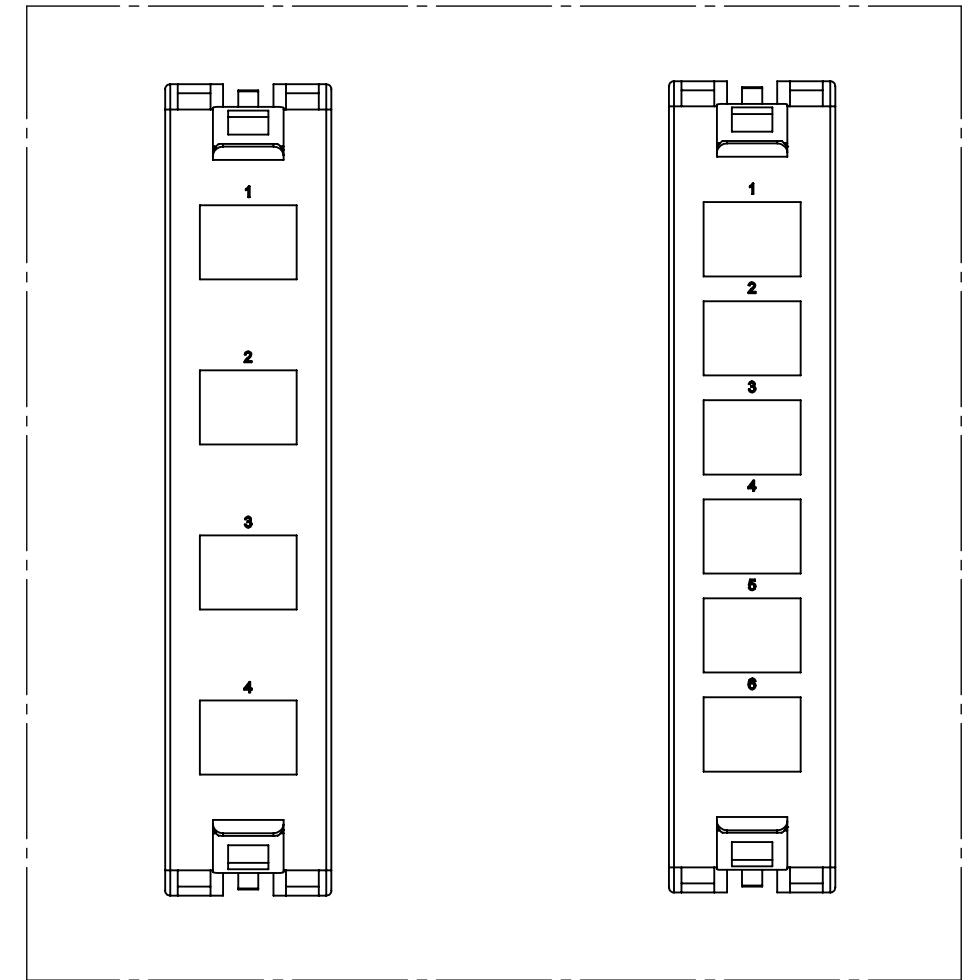

PRODUCT FAMILY : FX ECX Frame (X) Keyconnect  
FC\_X\_KC

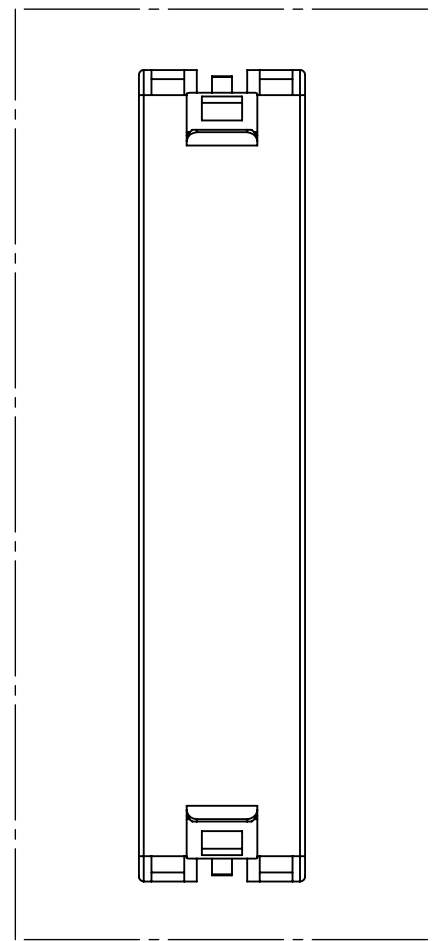

PRODUCT FAMILY : FX ECX Frame (X) Blank  
FC\_X\_BB

**PROPRIÉTÉ INTELLECTUELLE**  
L'information contenue dans ce document est la propriété de BELDEN Inc. Sauf si spécifié par une autorisation écrite de BELDEN Inc, la personne qui consulte ce document : (1) doit garder confidentielle toute l'information contenue dans ce document et doit protéger en tout ou en partie toute divulgation à toute tierce personne et (2) doit utiliser l'information pour la production ou la mise à jour.

**PROPRIETARY INFORMATION**  
*The information contained in this document is the property of BELDEN INC. Except as specifically authorized in writing by BELDEN, INC, the holder of this document: (1) shall keep all information contained herein confidential and shall protect same in whole or in part from disclosure and dissemination to all third parties and (2) shall use same for operating and maintenance purposes only.*

**DESSIN NON À L'ÉCHELLE**  
CE DESSIN REPRÉSENTE LE PRODUIT FINI, ET DOIT ÊTRE CONSIDÉRÉ À TITRE DE RÉFÉRENCE SEULEMENT

**DO NOT SCALE DRAWING**  
THIS DRAWING REPRESENTS FINISH PRODUCT AND SHOULD BE CONSIDERED AS REFERENCE ONLY

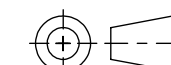
ORIENTATION:  



TITRE / TITLE:  
**FX ECX PATCH PANEL FRAMES**

DESSIN NO / DRAWING. NO. <b>BELDEN-535</b>	REV <b>A</b>
---	-----------------

DESSINÉ PAR: LE  
DRAWN BY: **AB** ON THE **03 Feb 2017**

FORMAT SIZE <b>C</b>	POIDS / WEIGHT lbs (Ref)	FEUILLE DE SHEET <b>4 OF 4</b>
-------------------------	-----------------------------	-----------------------------------